

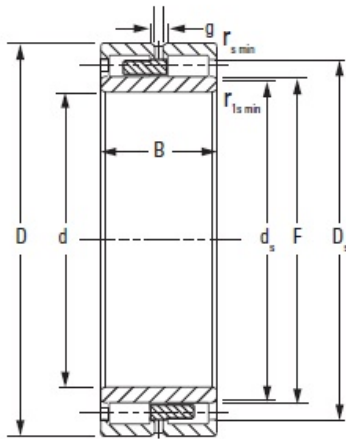

Hebei Xiantong Bearing Co., Ltd.



NNU4092MAW33 Timken Cylindrical Roller Bearing

Bearing No. NNU4092MAW33

Bore d	460.000 mm
O.D. D	680.000 mm
Width B	218.000 mm
DUR/DOR F/E	513.000 mm
Static Load Rating C_0	9420 kN
Dynamic Load Rating C_1^1	4980 kN
Geometry Factor C_g^2	0.3050
Thermal Speed Ratings - Oil	370 rpm
Thermal Speed Ratings - Grease	340 rpm
Weight	529.000 lb
Chamfer r_{smin}	6.00 mm
Chamfer r_{1smin}^3	6.0 mm
Backing Shaft Diameter d_s	502.0 mm
Backing Housing Diameter D_s	633.0 mm
Lubrication Groove g	19.3 mm
Lubrication Hole Diameter h	9.5 mm
Number of Lubrication Holes	12
Dimension S^4	8.40 mm

NNU4092MAW33 Bearing 2D drawings and 3D CAD models