

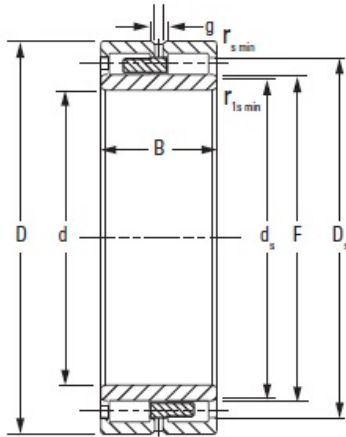

Hebei Xiantong Bearing Co., Ltd.



NNU4088MAW33 Timken Cylindrical Roller Bearing

Bearing No. NNU4088MAW33

Bore d	440.000 mm
O.D. D	650.000 mm
Width B	212.000 mm
DUR/DOR F/E	487.000 mm
Static Load Rating C_0	8180 kN
Dynamic Load Rating C_1^1	4530 kN
Geometry Factor C_g^2	0.2900
Thermal Speed Ratings - Oil	410 rpm
Thermal Speed Ratings - Grease	380 rpm
Weight	474.000 lb
Chamfer r_{smin}	6.00 mm
Chamfer r_{1smin}^3	6.0 mm
Backing Shaft Diameter d_s	478.0 mm
Backing Housing Diameter D_s	607.0 mm
Lubrication Groove g	19.3 mm
Lubrication Hole Diameter h	9.5 mm
Number of Lubrication Holes	12
Dimension S^4	8.80 mm

NNU4088MAW33 Bearing 2D drawings and 3D CAD models