

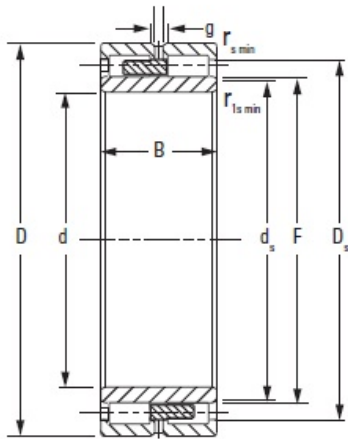

Hebei Xiantong Bearing Co., Ltd.



NNU4072MAW33 Timken Cylindrical Roller Bearing

Bearing No. NNU4072MAW33

Bore d	360.000 mm
O.D. D	540.000 mm
Width B	180.000 mm
DUR/DOR F/E	405.000 mm
Static Load Rating C_0	5580 kN
Dynamic Load Rating C_1^1	3180 kN
Geometry Factor C_g^2	0.2480
Thermal Speed Ratings - Oil	560 rpm
Thermal Speed Ratings - Grease	510 rpm
Weight	309.000 lb
Chamfer r_{smin}	5.00 mm
Chamfer r_{1smin}^3	5.0 mm
Backing Shaft Diameter d_s	400.0 mm
Backing Housing Diameter D_s	507.0 mm
Lubrication Groove g	19.3 mm
Lubrication Hole Diameter h	9.5 mm
Number of Lubrication Holes	10
Dimension S^4	7.90 mm

NNU4072MAW33 Bearing 2D drawings and 3D CAD models