

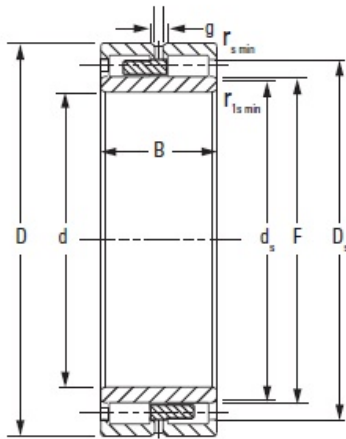

Hebei Xiantong Bearing Co., Ltd.



NNU4972MAW33 Timken Cylindrical Roller Bearing

Bearing No. NNU4972MAW33

Bore d	360.000 mm
O.D. D	480.000 mm
Width B	118.000 mm
DUR/DOR F/E	399.000 mm
Static Load Rating C_0	2800 kN
Dynamic Load Rating C_1^1	1270 kN
Geometry Factor C_g^2	0.2290
Thermal Speed Ratings - Oil	710 rpm
Thermal Speed Ratings - Grease	630 rpm
Weight	129.000 lb
Chamfer r_{smin}	3.00 mm
Chamfer r_{1smin}^3	3.0 mm
Backing Shaft Diameter d_s	392.0 mm
Backing Housing Diameter D_s	449.0 mm
Lubrication Groove g	19.3 mm
Lubrication Hole Diameter h	9.5 mm
Number of Lubrication Holes	8
Dimension S^4	5.60 mm

NNU4972MAW33 Bearing 2D drawings and 3D CAD models