

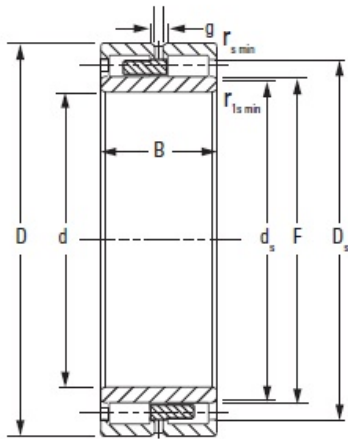

Hebei Xiantong Bearing Co., Ltd.



NNU4160MAW33 Timken Cylindrical Roller Bearing

Bearing No. NNU4160MAW33

Bore d	300 mm
O.D. D	500.000 mm
Width B	200.000 mm
DUR/DOR F/E	351.000 mm
Static Load Rating C_0	6140 kN
Dynamic Load Rating C_1^1	3780 kN
Geometry Factor C_g^2	0.2360
Thermal Speed Ratings - Oil	600 rpm
Thermal Speed Ratings - Grease	560 rpm
Weight	348.000 lb
Chamfer r_{smin}	5.00 mm
Chamfer r_{1smin}^3	5.0 mm
Backing Shaft Diameter d_s	343.0 mm
Backing Housing Diameter D_s	463.0 mm
Lubrication Groove g	12.0 mm
Lubrication Hole Diameter h	6.0 mm
Number of Lubrication Holes	8
Dimension S^4	6.50 mm

NNU4160MAW33 Bearing 2D drawings and 3D CAD models