

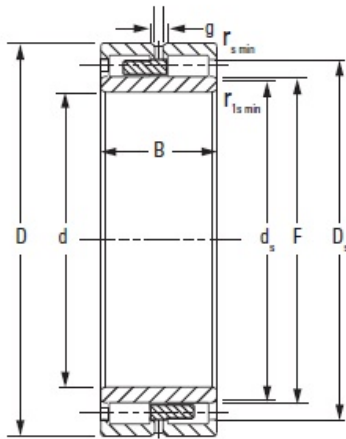

Hebei Xiantong Bearing Co., Ltd.



NNU4944MAW33 Timken Cylindrical Roller Bearing

Bearing No. NNU4944MAW33

Bore d	220 mm
O.D. D	300.000 mm
Width B	80.000 mm
DUR/DOR F/E	245.000 mm
Static Load Rating C_0	1150 kN
Dynamic Load Rating C_1^1	577 kN
Geometry Factor C_g^2	0.1570
Thermal Speed Ratings - Oil	1400 rpm
Thermal Speed Ratings - Grease	1200 rpm
Weight	36.400 lb
Chamfer r_{smin}	2.10 mm
Chamfer r_{1smin}^3	2.1 mm
Backing Shaft Diameter d_s	240.0 mm
Backing Housing Diameter D_s	279.0 mm
Lubrication Groove g	12.3 mm
Lubrication Hole Diameter h	6.0 mm
Number of Lubrication Holes	6
Dimension S^4	3.90 mm

NNU4944MAW33 Bearing 2D drawings and 3D CAD models